

LECTURES – COLLEGE de FRANCE, MAY 2016
2nd LECTURE

PCE STAMP (UBC)



For all online material:

<http://www.phas.ubc.ca/~berciu/PHILIP/TEACHING/CF/index.html>

http://www.college-de-france.fr/site/jean-dalibard/guestlecturer-2015-2016__1.htm

CONTACT: stamp@phas.ubc.ca

LECTURE 2

FROM QUBITS

to

SPIN NETS - 1

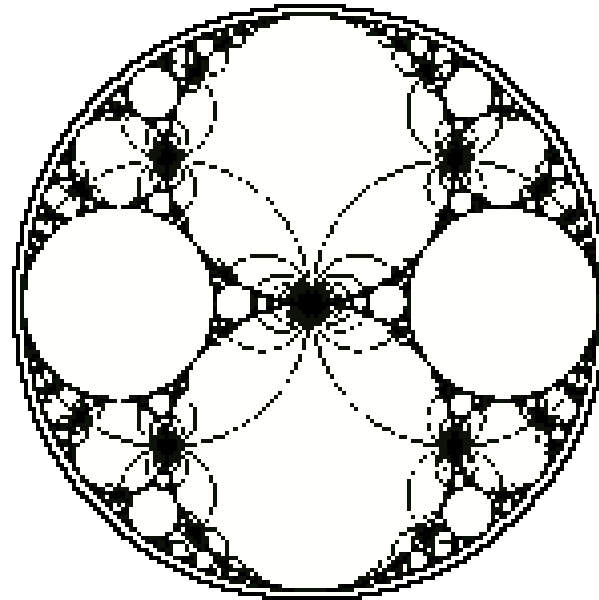
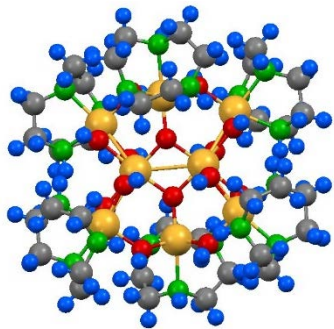

DIFFERENT KINDS of NETWORK in NATURE

REGULAR SOLID ARRAYS: Nature is full of ordered solid structures (some of which played a role in the formation of early biomolecules). Even apparently amorphous solids are usually polycrystalline. The unit cell of these crystals can of course be very complex - molecular crystals are rather common. Of special interest to us will be ordered structures involving 'spin molecules', which are candidates for quantum information processing systems



'Whisker' Epsomite crystals

Even when there is no obvious spatial order in the system, there may be 'hidden order', encoded in some way in the structure. This happens in disordered spin glasses & in spatially disordered systems - it has been described in theories of 'ultrametric geometry'

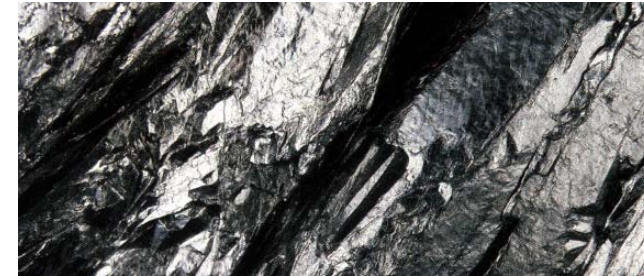

The surface of a lump of graphite, with its layered structure visible. Interstellar grains and dust look similar.

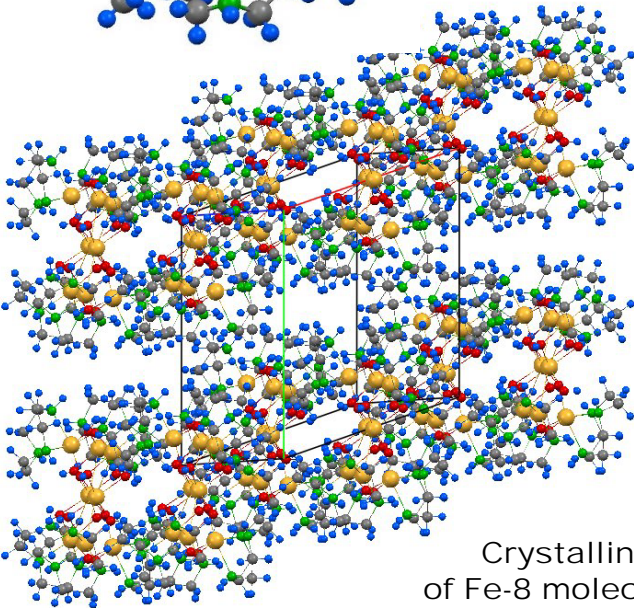
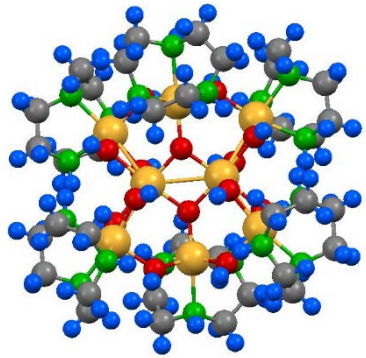

Crystalline array of Fe-8 molecules (basic unit shown at top)

R Rammal, G Toulouse, M Virasoro, Rev Mod Phys 58, 765 (1986)

BELOW: The hierarchical structure of 'glassy states' in a disordered solid.

RIGHT: Typical structure of a completely amorphous solid.

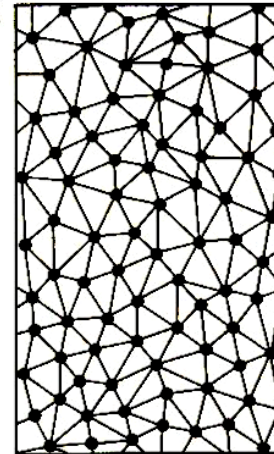
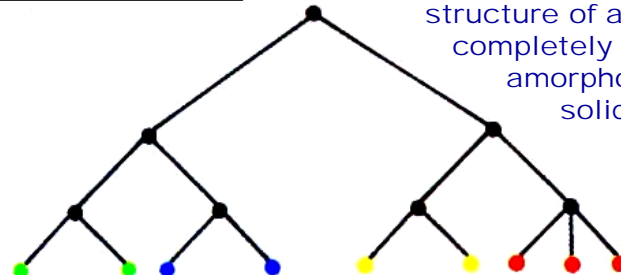

NETWORK STRUCTURE OF the BIOSPHERE

An alien intelligence passing the earth is far more likely to notice the incredible array of interacting information & control cycles and loops (extending from global to nanoscopic in scale), than it is to notice individual species. It will notice the role here

BELOW: various aspects of the Circadian network

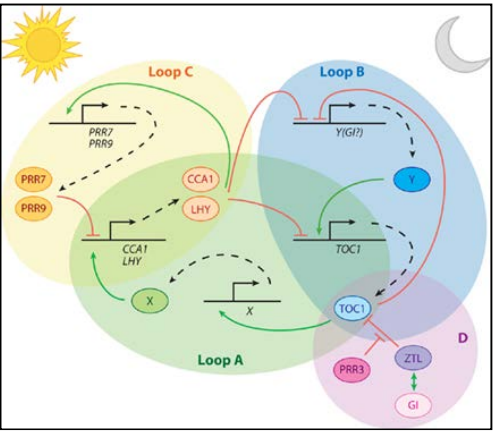

(as elsewhere in the universe) of autocatalytic nets in creating & evolving this structure.

These networks are powered by solar & geothermal energy. Only one of them (operating out of germ cells) involves the "central dogma" of information flow – all others involve flow & control in multiple directions (ie., a "Lamarckian" structure). Quantum interference & entanglement are largely absent.

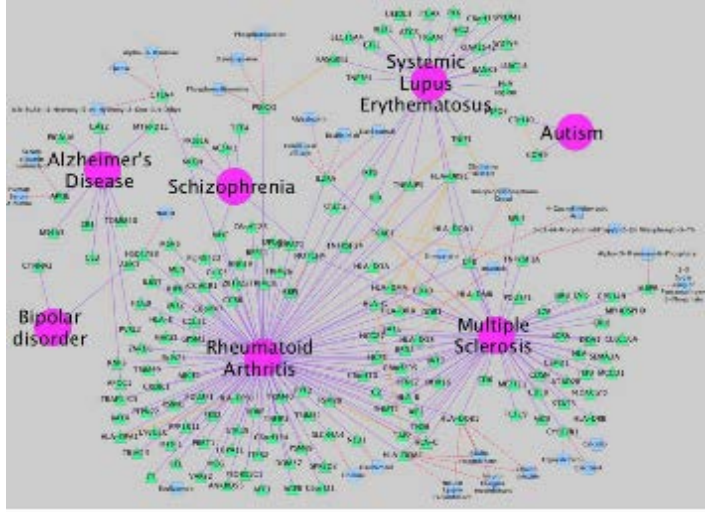

ABOVE: Small part of a "disease network" involving the "central dogma" of information flow – all others involve flow & control in multiple directions (ie., a "Lamarckian" structure). Quantum interference & entanglement are largely absent.

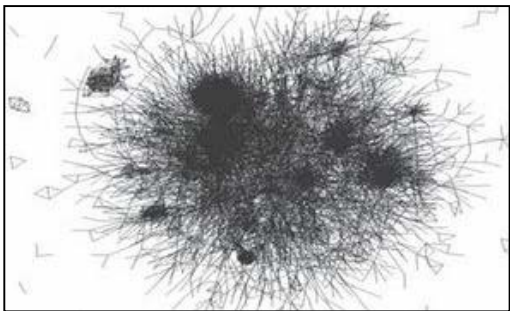
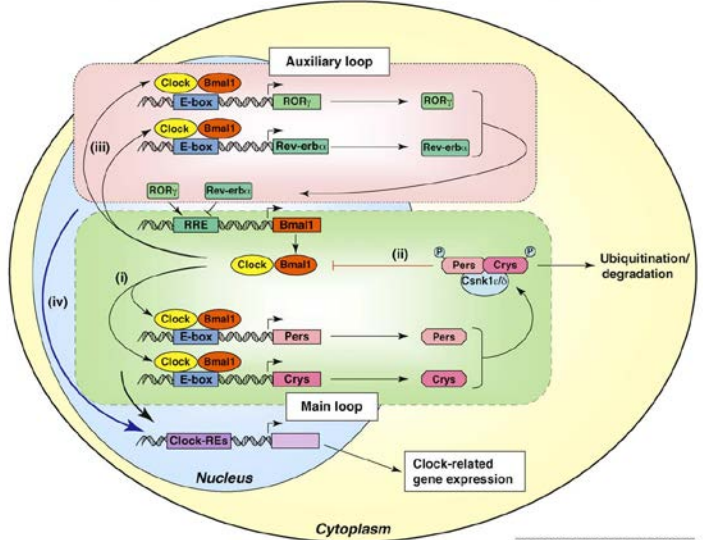

Map of a gene-protein network

There is extensive 'duality' in these nets between 'nodes' & 'links'

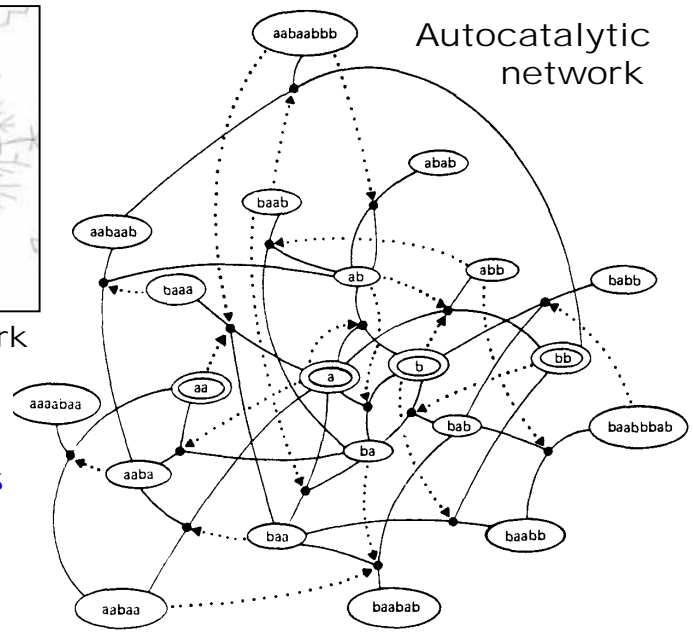

QUANTUM COHERENCE & RELAXATION in BIOLOGICAL NETWORKS

A key question - of great current interest - is the role of large-scale quantum superpositions and entanglement in biological processes.

EXAMPLE 1: EPR-style entanglement between 2 separate spins in cryptochrome molecules (avian navigation); the Hamiltonian is:

$$H = \sum_{k=1,2} H_k = -\gamma_e \vec{B} \cdot \sum_k \vec{S}_k + \sum_{k,j} \vec{S}_k \cdot \hat{\lambda}_{k_j} \cdot \vec{I}_{k_j}$$

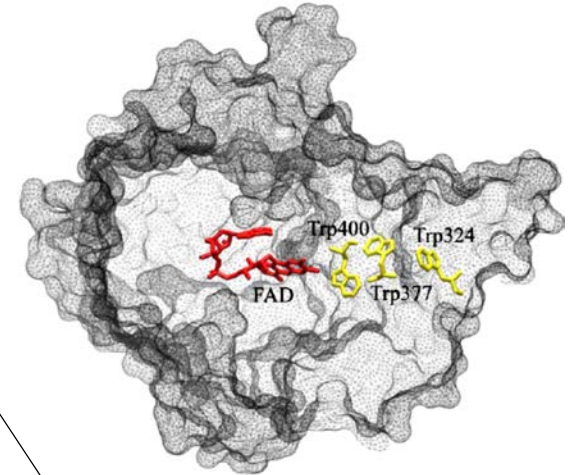

Arabidopsis Thaliana cryptochrome-1

EXAMPLE 2: Coherent motion of excitons delocalized amongst chromophores in Light Harvesting molecules, with Hamiltonian:

$$H_o = \sum_{ij} \left[t_{ij} c_i^\dagger c_j e^{iA_{ij}^o} + H.c. \right] + \sum_j \epsilon_j c_j^\dagger c_j$$

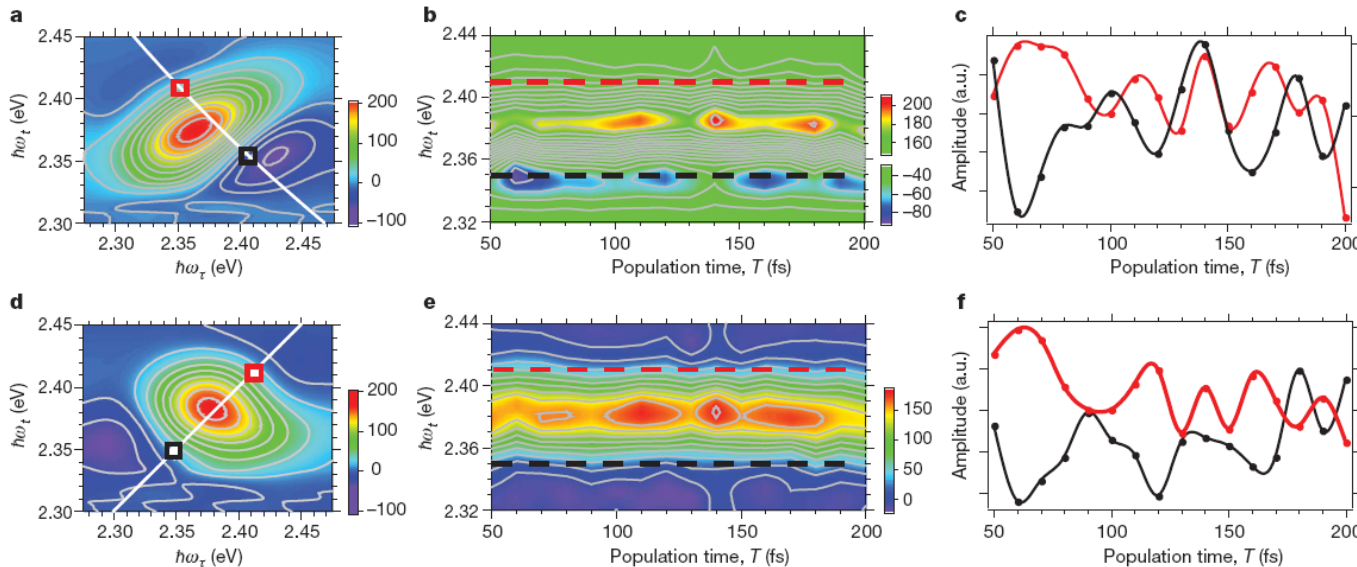

chlorosome (green sulfur bacteria)

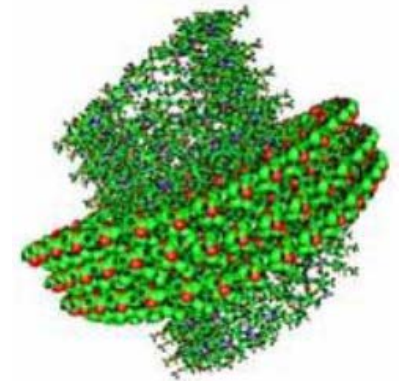

E Collini et al.,
Nature 463, 644 (2010)

NETWORKS OF QUBITS

Interacting qubit arrays exist naturally, in biological systems, in deep space masers (molecular clouds and AGNs), & elsewhere.

The most common current use of them is in industrial lasers & optical telecommunications.

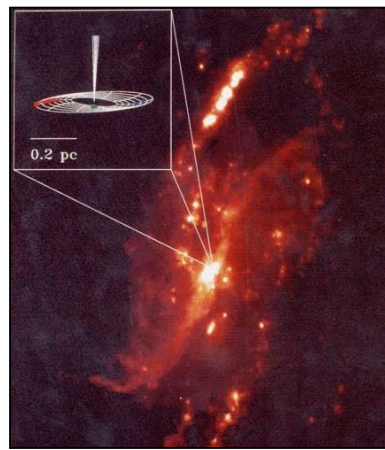

FAR LEFT: AGN megamaser in NGC 4258; MIDDLE: Methanol maser in molecular cloud; RIGHT: earth-based green laser

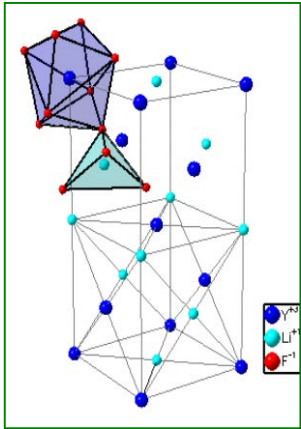

ABOVE: LiHoF₄, unit cell

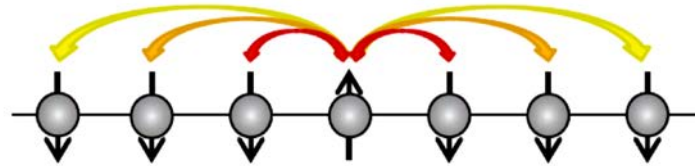

ABOVE: Interactions in ⁴⁰Ca⁺ ion spin chain

Intense interest currently focusses on making programmable qubit arrays. Popular candidates include spins in ion traps, spins in solid state insulators or semiconductors, & superconducting SQUID-based arrays. All of these have problems with environmental decoherence

BELOW: superconducting and Si:P qubits

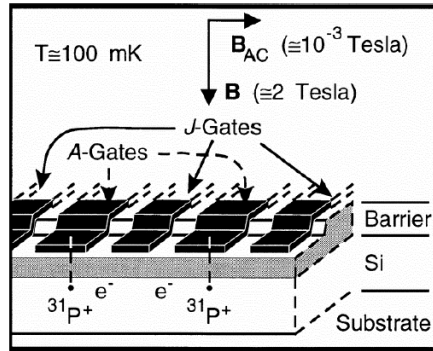
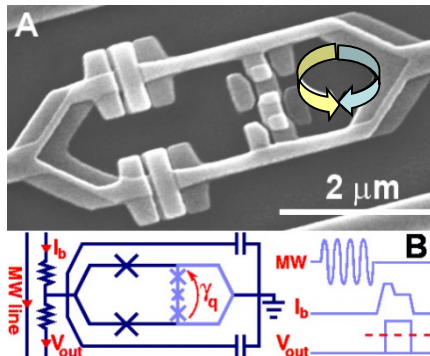

There already exists a large (1024-qubit) SQUID-based array used for quantum annealing/optimization (the d-wave system).

BELOW: d-wave Q annealing chip; & vision of Q internet

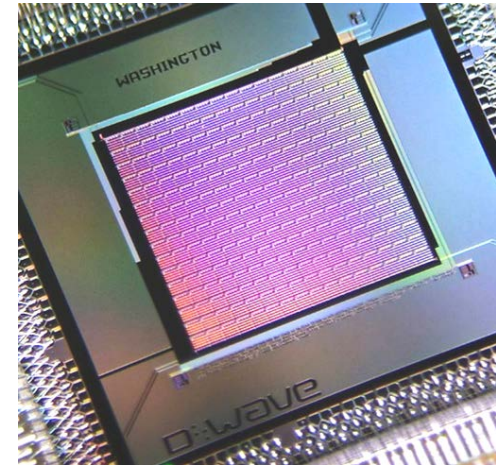

QUANTUM INFO & QUANTUM WALKS

Qubit networks can be mapped onto "quantum walks" (the latter are more general however). Thus any gate quantum computer can be represented more simply as a quantum walk.

BELOW: typical gate structure in a Q Computer

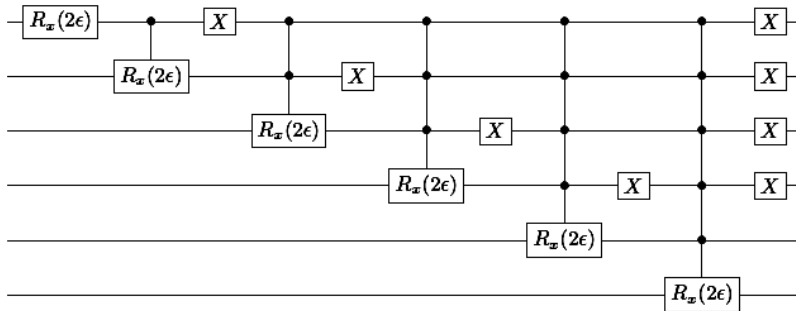

AP Hines, PCE Stamp, Phys Rev A75, 062321 (2007)

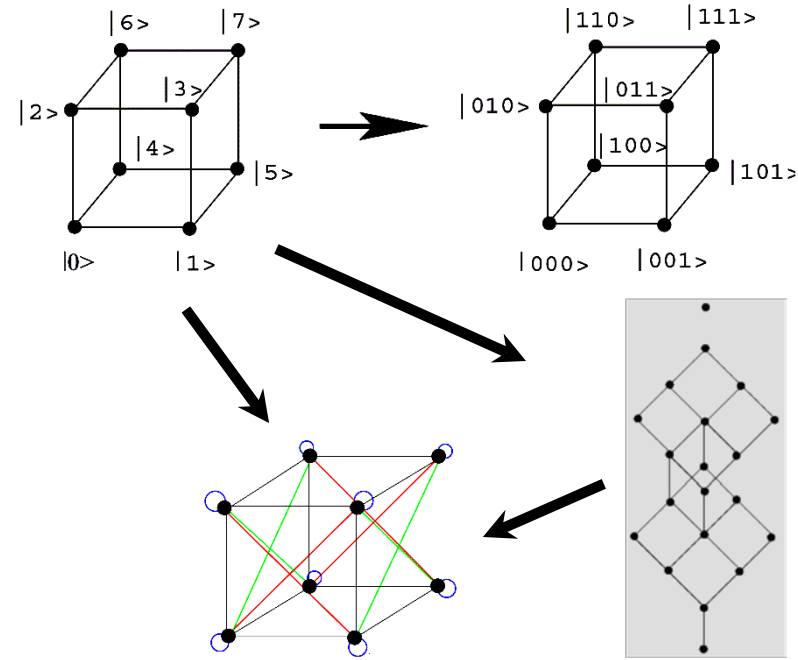

ABOVE: Mapping between 3d 'hypercube' Quantum Walk & 3-qubit system

The quantum walks are in information space, between nodes representing states in Hilbert space. The generic Hamiltonian is

$$\hat{H}_s = - \sum_{ij} \Delta_{ij}(t) (\hat{c}_i^\dagger \hat{c}_j + \hat{c}_i \hat{c}_j^\dagger) + \sum_j \epsilon_j(t) \hat{c}_j^\dagger \hat{c}_j$$

where the node energy and hopping matrix elements are in general time-dependent.

Decoherence (the key problem in Q computing) is not yet in this Hamiltonian; we need a quantum environment for this.

Graphs for quantum walks

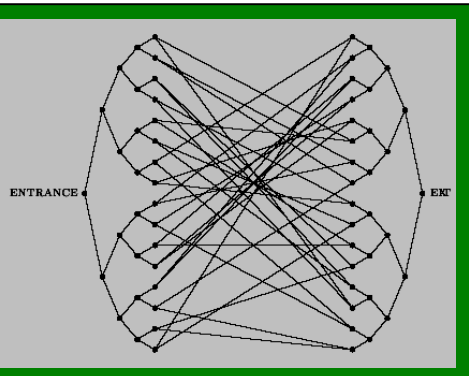
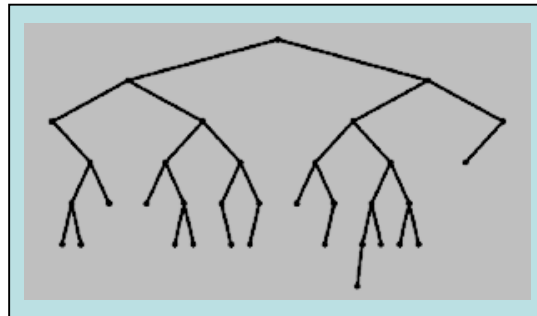

DYNAMICS of a SINGLE QUBIT

Here we go over the dynamics of a single qubit coupled to a bath. We first look at some elementary results, and then review the analytic results that are known for the 'spin-boson' and 'central spin' models

DYNAMICS of a SINGLE QUBIT - ELEMENTARY CONSIDERATIONS

The problem of a 2-level system (i.e., "qubit") coupled to an environment is one of the most widely discussed in all of physics. One calculates, using some scheme, the time-dependence of the qubit density matrix, given some initial state.

Consider, eg., the problem of a qubit with Hamiltonian

$$\mathcal{H}_o = \hbar(\Delta_o \hat{\tau}_x + \epsilon_o \hat{\tau}_z)$$

and put $\epsilon_o = 0$ (pure transverse field only); and then let the initial state be "up" (oriented along z). Then we expect the density matrix to behave like

$$2\rho(t) = \begin{pmatrix} (1 + e^{-\Gamma_1(t)} \cos(2\Delta_o t)) & ie^{-\Gamma_2(t)} \sin(2\Delta_o t) \\ -ie^{-\Gamma_2(t)} \sin(2\Delta_o t) & (1 - e^{-\Gamma_1(t)} \cos(2\Delta_o t)) \end{pmatrix}$$

If the decays are exponential in time, then we introduce timescales T_1 and T_2 (longitudinal & transverse relaxation times, otherwise known as energy relaxation and phase relaxation times; the phase relaxation time is also called the "decoherence time").

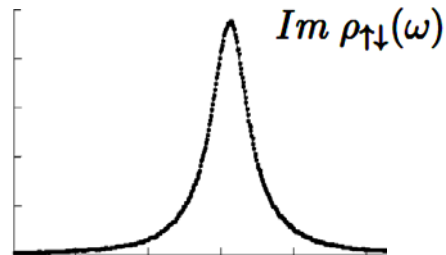
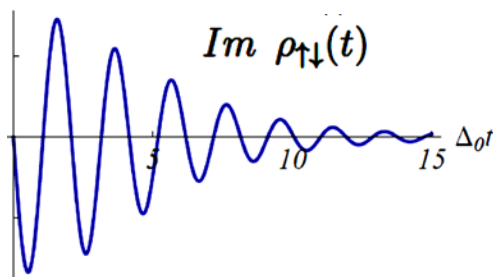

The phenomenology of this is well known (particularly in quantum optics) - see left.

The problem with the standard picture is that it is only valid if:

- (i) the bath only weakly perturbs the qubit and/or
- (ii) there are no memory/feedback effects from the bath

INTERLUDE: The FREE QUBIT

The free qubit has Hamiltonian $\mathcal{H}_o = \hbar(\Delta_o \hat{\tau}_x + \epsilon_o \hat{\tau}_z)$
 ie., we have a spin in a field oriented so that $\tan^{-1} \theta = \Delta_o / \epsilon_o$

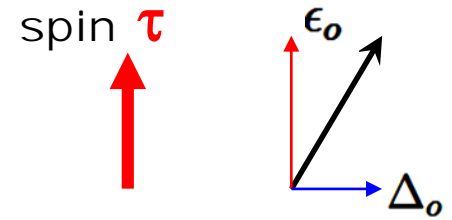

From elementary QM we have a qubit propagator

$$G^o(\tau_z, \tau'_z; t, t') \equiv G^o_{\sigma\sigma'}(t, t') = \langle \tau_z | e^{-i\mathcal{H}_o(t-t')/\hbar} | \tau'_z \rangle \quad (\text{Schrodinger})$$

and we also have $G^o_{\sigma\sigma'}(t, t') \equiv \int_{\tau'_z}^{\tau_z} \mathcal{D}\tau e^{\frac{i}{\hbar} \int_{t'}^t \mathcal{L}_o(\tau, \dot{\tau})} \quad (\text{path integral})$

SIMPLE TRANSVERSE CASE: Here we have $\epsilon_o = 0$ & the Schrodinger eqtn gives

$$G^o_{\sigma\sigma'}(t, t') = \delta_{\sigma, \sigma'} \cos \Delta_o t - i \delta_{\sigma, -\sigma'} \sin \Delta_o t$$

ie., we have $G^o_{\uparrow\uparrow}(t) = G^o_{\downarrow\downarrow}(t) = \cos \Delta_o t$ and $G^o_{\uparrow\downarrow}(t) = G^o_{\downarrow\uparrow}(t) = -i \sin \Delta_o t$

To derive this using a path integral, note that the infinitesimal action associated with a qubit flip at time $t = t_j$ is

$$dS = -i\Delta_o \delta(t - t_j) dt$$

Adding all the flips, we get, for an even number of flips:

$$G^o_{\uparrow\uparrow}(t) = \sum_{n=0}^{\infty} (-i\Delta_o)^{2n} \int_0^t dt_{2n} \int_0^{2t_{2n}} dt_{2n-1} \cdots \int_0^{t_2} dt_1 = \cos \Delta_o t$$

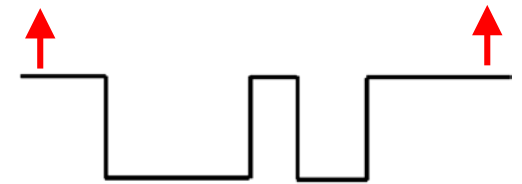

and for an odd number of flips we get:

$$G^o_{\uparrow\downarrow}(t) = \sum_{n=0}^{\infty} (-i\Delta_o)^{2n+1} \int_0^t dt_{2n+1} \int_0^{2t_{2n+1}} dt_{2n} \cdots \int_0^{t_2} dt_1 = -i \sin \Delta_o t$$



GENERAL CASE: From the Schrodinger eqtn we have, for example

$$G_{\uparrow\uparrow}^o(t) = \langle \uparrow | e^{-i(\Delta_o \hat{\tau}_x + \epsilon_o \hat{\tau}_z)t} | \uparrow \rangle = \cos E_o t + i \frac{\epsilon_o}{E_o} \sin E_o t$$

where $E_o^2 = (\epsilon_o^2 + \Delta_o^2)$

In a path integral treatment, a longitudinal field gives a contribution $dS = -i\epsilon_o \tau_z dt$ to the action. We then have

$$G_{\uparrow\uparrow}^o(t) = \sum_{n=0}^{\infty} (-i\Delta_o)^{2n} \int_0^t dt_{2n} e^{-i\epsilon_o(t-t_{2n})} \int_0^{2t_{2n}} dt_{2n-1} e^{+i\epsilon_o(t_{2n}-t_{2n-1})} \dots \int_0^{t_2} dt_1 e^{-i\epsilon_o t_1}$$

$$G_{\uparrow\downarrow}^o(t) = \sum_{n=0}^{\infty} (-i\Delta_o)^{2n+1} \int_0^t dt_{2n+1} e^{-i\epsilon_o(t-t_{2n+1})} \int_0^{2t_{2n+1}} dt_{2n} e^{+i\epsilon_o(t_{2n+1}-t_{2n})} \dots \int_0^{t_2} dt_1 e^{+i\epsilon_o t_1}$$

by summing over the same paths as before. Laplace transforming these convolutions, ie, writing $G_{\alpha\beta}^o(t) = \int_{-i\infty}^{i\infty} dp e^{pt} G_{\alpha\beta}^o(p)$

we get $G_{\uparrow\uparrow}^o(p) = \frac{1}{p - i\epsilon_o} \sum_{n=0}^{\infty} \frac{(-i\Delta_o)^{2n}}{(p^2 + \epsilon_o^2)^n} \equiv \frac{1}{p - i\epsilon_o} \frac{p^2 + \epsilon_o^2}{p^2 n + E_o^2}$ with $G_{\uparrow\uparrow}^o(t)$ given as above by inverse transform

DENSITY MATRIX - FULL DYNAMICS: We now sum over pairs of paths, to get the propagator for the free density matrix:

$$K_o(2, 2'; 1, 1') = \int_{Q_1}^{Q_2} dQ \int_{Q'_1}^{Q'_2} dQ' e^{-i/\hbar(S_o[Q] - S_o[Q'])}$$

Consider, eg., the "return probability" for the spin to start & finish in the "up" state; for the pure transverse field this is:

$$K_{\uparrow\uparrow; \uparrow\uparrow}^o(t, t') \equiv P_{\uparrow\uparrow}^o(t, t') = \sum_{nm} (i\Delta_o)^{2(n+m)} \int_0^t dt_1 \dots \int_{t_{2n-1}}^t dt_{2n} \int_0^{t'} dt'_1 \dots \int_{t'_{2m-1}}^{t'} dt'_{2m}$$

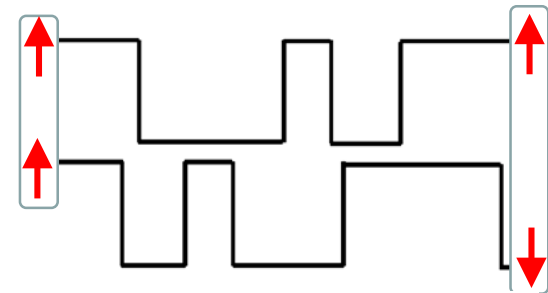

Ex: Paths for $K_{\uparrow\uparrow; \uparrow\uparrow}^o(t, t')$

QUBIT COUPLED to a BATH

Now we have to include the 'influence functional' weighting factor, ie., we write

$$\mathcal{K}(2, 2'; 1, 1') = \int_{Q_1}^{Q_2} dQ \int_{Q'_1}^{Q'_2} dQ' e^{-i/\hbar(S_0[Q]-S_0[Q'])} \mathcal{F}[Q, Q']$$

so that, eg., we have

$$\mathcal{K}_{\uparrow\uparrow; \uparrow\uparrow}(t, t') \equiv P_{\uparrow\uparrow}(t, t') = \sum_{nm} (i\Delta_0)^{2(n+m)} \int_0^t dt_1 \cdots \int_{t_{2n-1}}^t dt_{2n} \int_0^{t'} dt'_1 \cdots \int_{t'_{2m-1}}^{t'} dt'_{2m} \mathcal{F}[Q_{(n)}, Q_{(m)}]$$

However, this works out very differently for oscillator and spin baths:

OSCILLATOR BATHS: we define variables $Q(t) = [\tau_z(t) + \tau'_z(t)]$ and $\xi(t) = [\tau_z(t) - \tau'_z(t)]$

Then $\mathcal{F}[Q, \xi] = \exp \left[\frac{i}{\hbar} \int^t d\tau \int^{\tau} d\tau' [\Phi(\tau - \tau') Q(\tau) \xi(\tau') - i\Gamma(\tau - \tau') \xi(\tau) \xi(\tau')] \right]$

where $\Phi(t) = \int_0^\infty \frac{d\omega}{\pi} J(\omega) \sin \omega t$

$$\Gamma(t) = \int_0^\infty \frac{d\omega}{\pi} J(\omega) \cos \omega t \coth \frac{\beta \hbar \omega}{2}$$

Decoherence functional

Everything then depends on the range in time of the decoherence functional

SPIN BATHS: we can write as above - but it turns out to be better to write the results for the final density matrix in the quite remarkable form:

$$\rho(Q, Q'; t) = \underbrace{\hat{\mathcal{A}}^T(\phi) \hat{\mathcal{A}}^O(y) \hat{\mathcal{A}}^B(\epsilon, M)}_{\text{3 averages}} \underbrace{\rho^{(0)}(\phi, y, \epsilon, M; Q, Q'; t)}_{\text{Free qubit density matrix}}$$

with averages acting on a FREE qubit form, with renormalized parameters (see later)

Dynamics of SPIN-BOSON MODEL

COUPLING to PHOTONS or PHONONS: Here the coupling is infra-red weak; the decoherence functional is strongly local in time, and we get rather simple results. Thus, eg., we have, for arbitrarily strong coupling

$$P_{\uparrow\uparrow}(t, t') = \cos[\tilde{\Delta}(\beta)t] \exp[-\Gamma_s(\beta)t]$$

with renormalized parameters:

$$\tilde{\Delta} = \Delta \exp \left[-\frac{q_0^2}{2\pi\hbar} \int_0^\infty d\omega \frac{J(\omega)}{\omega^2} \right]$$

$$\Gamma_s(\beta) = \frac{q_0^2}{4\hbar} J(\tilde{\Delta}) \coth[\beta\hbar\tilde{\Delta}(\beta)/2]$$

Thus the simple results used in the literature are justified.

OHMIC COUPLING: This case describes coupling to, eg., electrons, or to low-dimensionality phonons or magnons. For the transverse field case we have a relaxation rate

$$\tau(T)^{-1} = \frac{\Delta_o^2}{\Omega_o} \frac{\Gamma^2(\alpha)}{\Gamma^2(2\alpha)} \left(\frac{2\pi kT}{\Omega_o} \right)^{2\alpha-1}$$

At $T=0$ all coherent oscillations cease when the dimensionless coupling $\alpha > 1/2$; and when $\alpha > 1$ the qubit localizes, ie., its dynamics is completely frozen (a freezing which is alleviated at finite T). The phase diagram is shown at left.

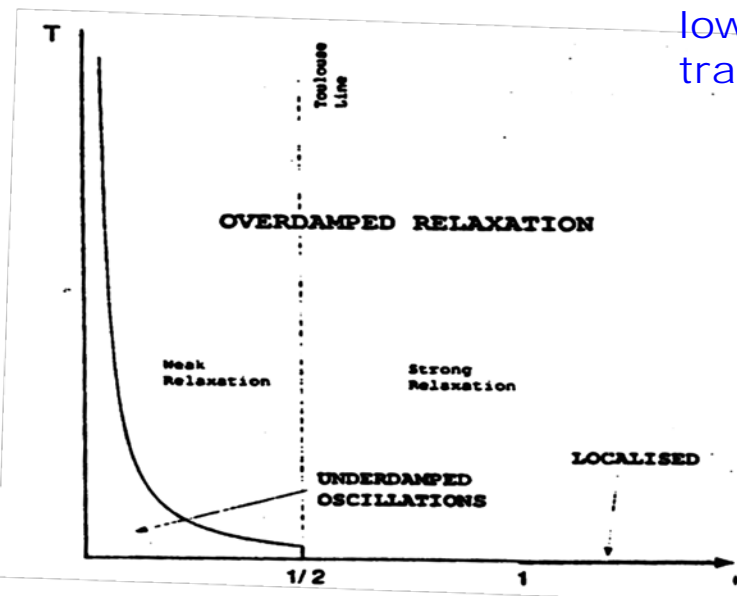

DYNAMICS of CENTRAL SPIN MODEL

As noted above, the result here can be written in the form

$$\rho(Q, Q'; t) = \hat{\mathcal{A}}^T(\phi) \hat{\mathcal{A}}^O(y) \hat{\mathcal{A}}^B(\epsilon, M) \rho^{(0)}(\phi, y, \epsilon, M; Q, Q'; t)$$

where the function $\rho^{(0)}(\phi, y, \epsilon, M; Q, Q'; t)$ has the same form as the bare density matrix, but with renormalized parameters. Thus, eg., the 'return probability' renormalized bare density matrix element is

$$P_{11}^{(0)}(t; \Delta_M(\varphi, x); \epsilon) = 1 - \frac{\Delta_M^2(\varphi, x)}{E_M^2(\varphi, x)} \sin^2(E_M(\varphi, x)t)$$

where $\Delta_M(\varphi, x) = 2\tilde{\Delta}_0 |\cos(\varphi) J_M(2x\sqrt{\gamma})|$, where $E_M^2(\varphi, x) = \Delta_M^2(\varphi, x) + \epsilon^2$, and where the averages are as follows:

Topological phase average: There is a pure phase decoherence, summing over winding numbers of the spin bath phase:

$$\hat{\mathcal{A}}^T(\phi) = \sum_{v=-\infty}^{\infty} \int_0^{2\pi} e^{iv\phi - 4\lambda v^2}$$

Precessional phase average: By far the most important decoherence mechanism comes from the precession of the bath spins in the field of the central qubit.

Each time the qubit flips, the field on each bath spin jumps Between 2 possible values. Each bath spin then undergoes a succession of precessions that are conditional on the path of the central qubit. This is just another way of saying that each bath spin progressively entangles with the central qubit. The average is

$$\hat{\mathcal{A}}^O(y) = \int_0^{\infty} dx x e^{-x^2}$$

Neither of these 2 mechanisms involves dissipation/energy exchange - only decoherence

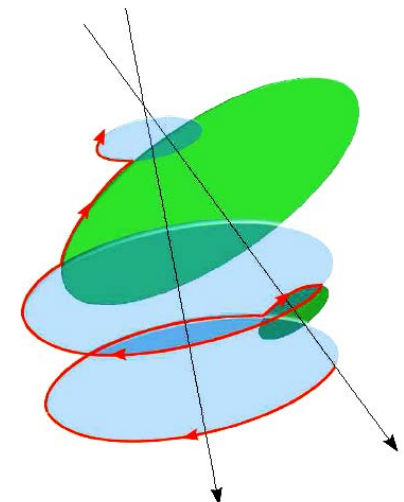

Degeneracy blocking/energy averaging: The coupling of a central qubit to a bath of N different 2-level bath degrees of freedom leads to a large spread in the energy levels of the bath.

A key concept here is the “ M -th polarization group”, consisting of all bath states with polarization

$$M = \sum_{k=1}^N \sigma_k^z$$

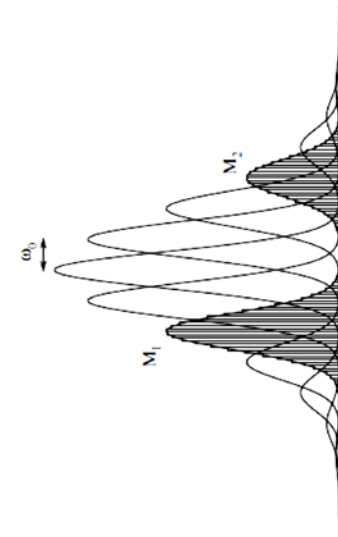
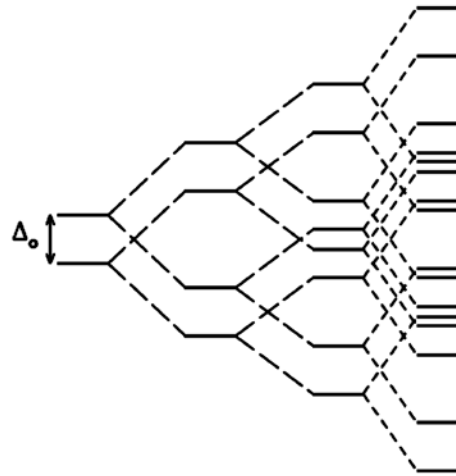

When the frequency scale of qubit dynamics is very different from the bath spin energy scale, the bath moves quite slowly between different polarization groups. The qubit finds it hard to tunnel when M is large (it is far from resonance); hence the strong renormalization of the matrix element.

In any case, we need to average over all these states; this gives an average of form:

$$\hat{\mathcal{A}}^B(\epsilon, M) = \int d\epsilon W(\epsilon) \frac{e^{-\beta\epsilon}}{Z(\beta)} \sum_M$$

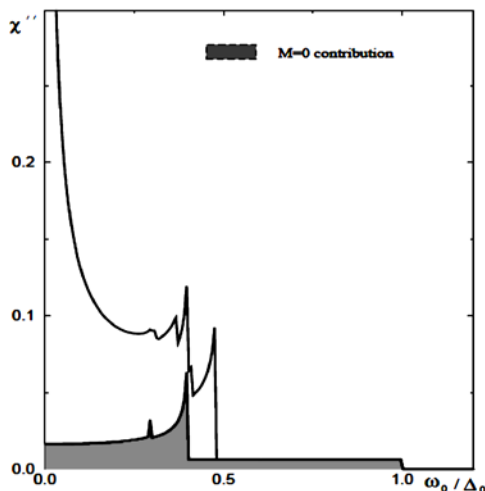

The net result of all this leads to a wide variety of possible behaviours. Many of them are rather unconventional, when the coupling to the spin bath is not weak. A typical example is shown at left – the absorption spectrum is very far from being a Lorentzian peak.

REAL WORLD PROBLEM #2

QUANTUM DYNAMICS

of a

SOLID-STATE QUBIT

QUANTUM DYNAMICS of a single Fe-8 MOLECULE

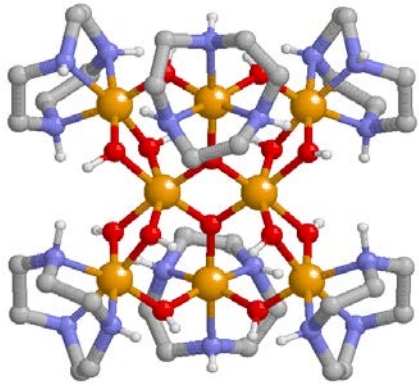

Fe₈ S = 10

The core of this molecule is a cluster of 8 Fe ions, of varying ionicities. This core is surrounded by organic ligands.

Superexchange interactions between the Fe spins create a 'giant spin' $S = 10$, with effective Hamiltonian:

$$\mathcal{H}(\mathbf{S}) = -DS_z^2 + ES_x^2 + K_4^{\perp}(S_+^4 + S_-^4) - \gamma\mathbf{S} \cdot \mathbf{H}_{\perp}$$

The values of the constants are:

$$D/k_B = 0.23 \text{ K}$$

$$E/k_B = 0.094 \text{ K}$$

$$K_4^{\perp}/k_B = -3.28 \times 10^{-5} \text{ K}$$

One way to look at this - as tunneling between the eigenstates of the $-DS_z^2$ longitudinal term - such transitions are shown below

Another fruitful way to look at it is using a path integral representation. The spin moves in a potential on the Bloch sphere, with 2 potential wells at the poles, and 2 "hills" along the x-axis. There are thus TWO tunneling paths - we have an "Aharonov-Bohm effect in spin space".

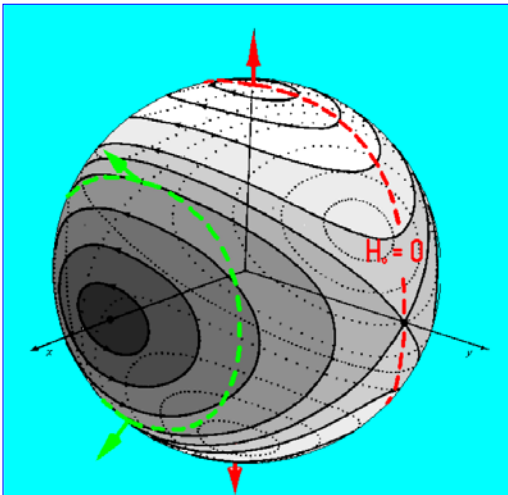

Feynman Paths on the spin sphere for a biaxial potential. Application of a field pulls the paths towards the field

Adding an external field alters this potential, and it alters the tunneling paths. If the field is along the x-axis, it simply reduces the height of the hill in the direction of the field (and increases the antipodal hill height).

The phase interference between the 2 paths is determined by the enclosed Berry-Haldane phase.

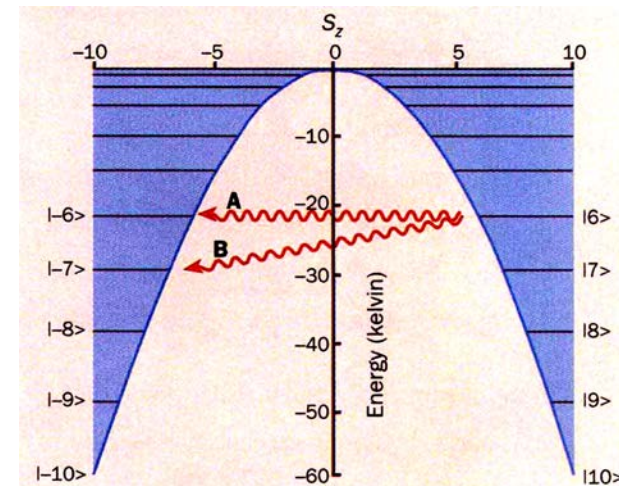

LOW-ENERGY EFFECTIVE HAMILTONIAN

In the Low-T Quantum regime, we have the effective Hamiltonian (**T < 0.36 K**):

$$\mathcal{H}_o(\hat{\tau}) = (\Delta_o \hat{\tau}_x + \epsilon_o \hat{\tau}_z)$$

with longitudinal bias $\epsilon_o = g\mu_B S_z H_o^z$

The transverse tunneling term is an extremely non-linear function of the applied transverse field: both its magnitude and direction (see left).

We label the eigenstates of the longitudinal part of this effective Hamiltonian as $|\uparrow\rangle, |\downarrow\rangle$

With no longitudinal field, the eigenstates are:

$$|\pm\rangle = [|\uparrow\rangle \pm |\downarrow\rangle] / \sqrt{2}$$

The effective g-factor of this qubit is highly anisotropic.

We thus have an effective qubit whose parameters can be varied over a very wide range of energies.

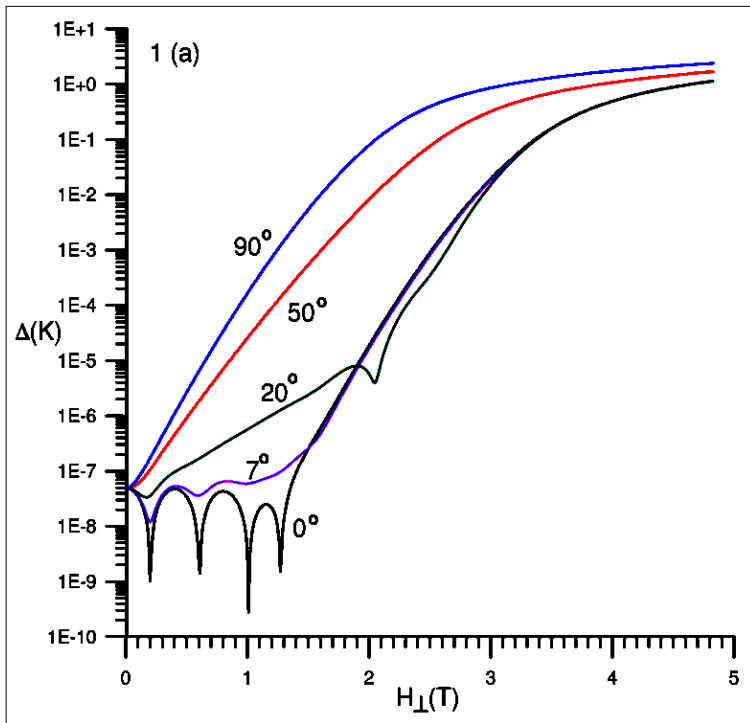
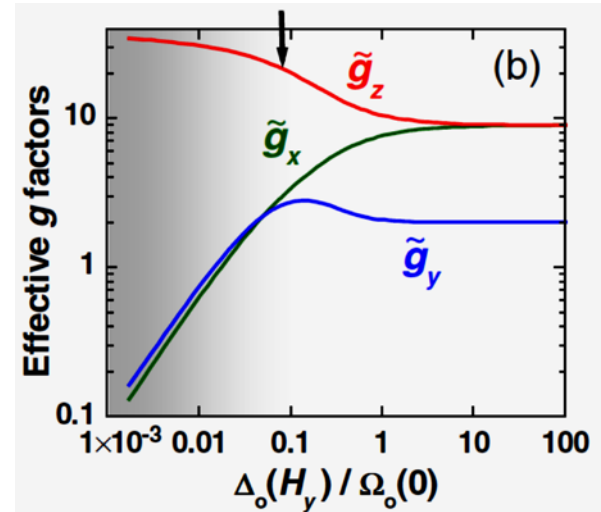

We can address such a qubit using microwave fields

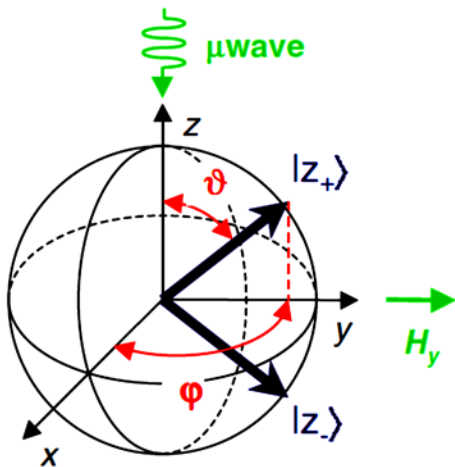

QUANTUM COHERENCE REGIME: here quantitative predictions were made long before any experiments were done.

DECOHERENCE IN Fe-8 SYSTEM

(A) Nuclear Spin Bath

The spin bath is made up of different nuclear spins, with a large variety of hyperfine couplings to Fe, Br, N, O, C, & H species. The effective Hamiltonian can be written

$$H_{eff}^{CS} = [\Delta_o \hat{\tau}_+ e^{-i \sum_k \alpha_k \cdot \sigma_k} + H.c.] + \hat{\tau}^z (\epsilon_o + \sum_k \omega_k \cdot \sigma_k) + H_{env}^{sp}([\sigma_k])$$

where the couplings are derived from the original hyperfine couplings.

Nuclear spin decoherence rate

For this system the decoherence rate actually reduces to a rather simple result, viz.,

$$\gamma_\phi^{NS} = E_o^2 / 2\Delta_o^2 \quad \text{where} \quad E_o^2 = \sum_k \frac{I_k + 1}{3I_k} (\omega_k^\parallel I_k)^2$$

The dimensionless rate is shown at right for different isotopic concentrations

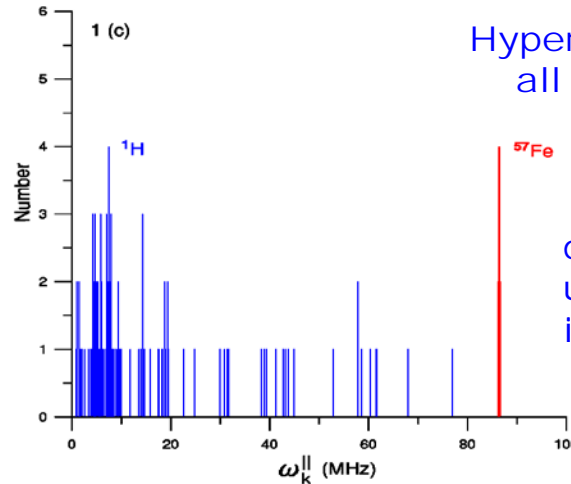

Hyperfine couplings of all 213 nuclear spins are well known. One can modify the spin bath decoherence rate using selective isotopic substitution

There is a very strong dependence on transverse field

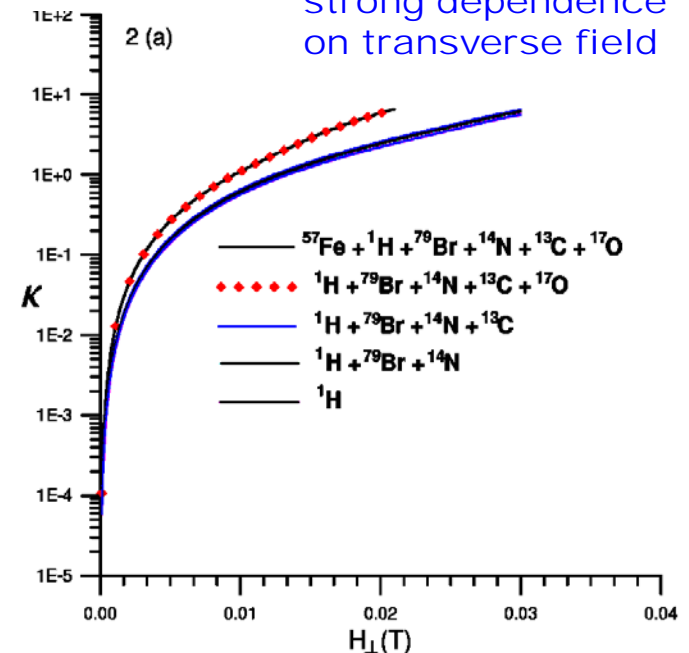

(b) Phonon Bath

Phonon spectrum and spin-phonon couplings are known. The phonon decoherence rate is:

$$\gamma_{\phi}^{\text{ph}} = \frac{\mathcal{M}_{\mathcal{A}\mathcal{S}}^2 \Delta_0^2}{\pi \rho c_s^5 \hbar^3} \coth\left(\frac{\Delta_0}{k_B T}\right)$$

where the matrix element is $\mathcal{M}_{\mathcal{A}\mathcal{S}}^2(H_y) \approx \frac{4}{3} D^2 |\langle \mathcal{A} | S_y S_z + S_z S_y | \mathcal{S} \rangle|^2$

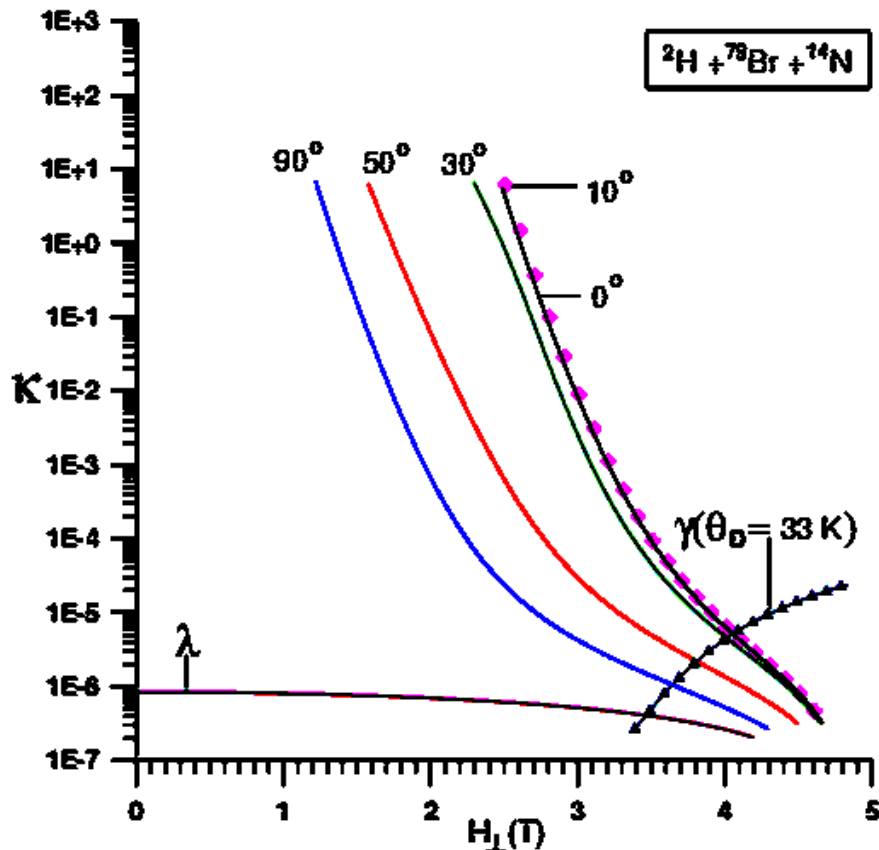

In low fields, the nuclear spins bath completely blocks the qubit dynamics. However, at high fields, the system can be in a **coherence window**, in which the qubit dynamics is too fast for nuclear spins to follow, but still much slower than the phonons.

This frequency window we call the coherence window- note that typically

$$E_o/\theta_D \lesssim 10^{-4}$$

We return to this coherence window again later - it is important for quantum computation

Stamp, P.C.E., Tupitsyn, I.S.,
Phys Rev B69, 014401 (2004)

A Morello+al, PRL 97, 207206 (2006)

S Takahashi + al, Nature 476, 76 (2011)